

# ***Octane***<sup>®</sup>

F I T N E S S



## ***PRO3700***

O P E R A T I O N S M A N U A L

**This product is intended for commercial use.**

## **PLEASE READ AND SAVE THESE INSTRUCTIONS**

# **I M P O R T A N T   S A F E T Y   I N S T R U C T I O N S**

**WARNING!** Anyone using this product should consult a physician before they start their exercise program. This is especially important for persons over 35 or those with pre-existing health conditions. If at any time during their workout exercisers experience chest pains, nausea, dizziness, or shortness of breath, they should stop exercising immediately and consult their physician before starting again.

Have all club, personal training, and sales staff members review this Operations Manual before operating this elliptical cross trainer. Also, make this Operations Manual accessible to all exercisers.

**WARNING!** When using an electrical product, basic precautions should always be followed.

To reduce the risk of burns, fire, electrical shock or injury to people:

- Use this exercise product for its intended use as described in this Operations Manual. **Do not** modify the product in any way.
- **Do not** remove the plastic shrouds from the machine. Service should be performed only by an authorized Octane Fitness service representative. Moving parts contained under the shrouds can be extremely dangerous when not covered.
- **Never** operate this elliptical cross trainer if it has a damaged cord or plug, if it is not working properly, if it has been dropped or damaged, or dropped in water. Return the cross trainer to your local dealer or Octane Fitness for examination and repair.
- **Never** operate this elliptical cross trainer with the air openings blocked. Keep the air openings free of lint, hair, and the like.
- **Do not** use outdoors..
- **Do not** operate this elliptical cross trainer where aerosol (spray) products are being used or where oxygen is being administered.
- **Do not** route power cables (such as the power cable for an optional attached LCD screen) through the interior of the machine or the upright tube.
- **Do not** mount an LCD screen weighing more than 8.5 lbs. (3.8 kg) on the optional LCD mounting arm.

## **SAVE THESE INSTRUCTIONS**

## OTHER IMPORTANT SAFETY PRECAUTIONS

- Place the elliptical cross trainer on a level surface with at least two feet of clearance behind the pedal at its farthest back position.
- If you have more than one unit, position them so that there are at least 24 inches (60 cm) between units.
- To protect the floor or carpet from damage, place a mat under your elliptical cross trainer.
- Keep children off the elliptical cross trainer at all times.
- When the elliptical cross trainer is in use, children and pets should be kept clear of the area.
- Wear appropriate exercise clothing and shoes for your workout; do not wear loose clothing.
- Use care when getting on or off the Octane Fitness elliptical cross trainer. Never step on or off the unit while the foot pedals are still moving.
- Always face forward. Never attempt to turn around on the Octane Fitness elliptical cross trainer.
- Do not sit, stand, or climb on the front plastic shroud, electronic console, or stationary handlebars.
- Keep your hands and feet clear of any opening or moving parts.
- Never insert or drop any object into any opening.
- Users should not overexert yourself or work to exhaustion.
- If during a workout an exerciser feels any chest pain, nausea, dizziness, or abnormal symptoms, stop the workout immediately and consult a physician.
- Wipe down external surfaces of your cross trainer after use to remove sweat and dust.
- Monitor and check your Octane cross trainer on a regular basis. Refer to the Cleaning and Maintenance section of this manual for more information about the care of your Octane cross trainer.
- Inspect all external parts of the elliptical cross trainer regularly. If service is required, contact your local dealer or Octane Fitness Customer Service for assistance.
- Take caution in moving your Octane Fitness elliptical cross trainer. Your elliptical weighs over 330 pounds. Use proper lifting technique and/or get assistance when moving your product.

Product Dimensions: 2108mm x 813mm x 1676mm  
(83in x 32in x 66in)  
Product Weight 320 lbs. (145 Kg)  
Max User Weight 400 pounds (181 Kg)

Power Supply/Electrical Specifications:  
This is a self-powered machine.

*This equipment complies where applicable with:*

2006/95EC	Low Voltage Directive
2004/108/EC	Electromagnetic Compatibility (EN61000)
2002/95/EC	Restriction of Hazardous Substances (RoHS) Directive
2006/96/EC	WEEE Directive
EN957-9:2003	Stationary training equipment
EN957-1:2005	Stationary training equipment
EN60335-1:2002	Household and similar electrical appliances - Safety
GPS	General Product Safety Regulations 2005

This device complies with part 15 of the FCC Rules. Operation is subject to the following two conditions: (1) This device may not cause harmful interference, and (2) this device must accept any interference received, including interference that may cause undesired operation.



# HEART RATE FEATURE SAFETY GUIDELINES

Before using the Octane Fitness PRO3700 with HeartLogic™ Intelligence, read and follow these instructions:

## Contact Heart Rate Grips

- Clean the contact heart rate grips periodically to remove sweat and oils. Use a damp cloth with a mild detergent. Do not spray the hand grips directly with water or a cleaner; this could cause an electrical short.
- When holding the grips, grasp each contact heart rate grip so the contact sensor portion of the grip rests in the palm of your hand. Grip the contact sensors firmly, and keep your hands steady and in place.

## Wireless Chest Strap

- Exercisers may use any Polar™-compatible (coded or non-coded) wireless heart rate transmitter with the Octane Fitness PRO3700.
- **Do not allow users to use the chest strap if they have a cardiac pacemaker or are taking prescription medication.** Medication or electrical impulses from the cardiac pacemaker can cause inaccurate heart rate readings.
- Please take care in handling the equipment as it is extremely sensitive.
- Do not bend the strips inside the chest strap as it can cause the strap to lose its conductivity.
- Handle the heart rate transmitter (chest strap) with care. Dropping the transmitter might cause damage and this could void the warranty.
- If the receiver (console) tries to process several signals simultaneously, an incorrect heart rate reading could result. In a commercial setting, space the products at least 24" apart. This will prevent cross-talk, where the chest strap signal from a user on one machine can be received and displayed on the console of another machine.
- Do not place the chest strap near devices that generate large magnetic fields. Television sets, electric motors, radios, and high voltage power lines can affect the transmitter's performance. These items can interfere with the heart rate signal that is being transmitted to the receiver, possibly affecting the heart rate readings that appear on the electronic console.
- Do not immerse the transmitter in water. However, some moisture is necessary for the transmitter to function properly. Perspiration is usually sufficient, but you may need to moisten the electrodes with a small amount of water. The electrodes are the ribbed portion on the side of the transmitter that sits against your skin.
- The wireless chest strap has a battery which may need to be replaced from time to time. A faulty battery or worn electrodes may cause inaccurate readings. The electrodes are the ribbed portion on the side of the transmitter that sits against your skin.
- To purchase wireless transmitter straps, contact your dealer or Octane Fitness sales representative.

Some individuals are unable to use the heart rate feature because they do not have the proper body chemistry to provide accurate readings. If you experience difficulties in using the contact heart rate grips or a wireless chest strap, contact your dealer or Octane Fitness Customer Service at 1.888.OCTANE4.

**WARNING!** The heart rate monitoring features of this product are for information only and are **not** to be used as a measure of heart functioning or heart health. In a heart rate controlled program, the exerciser can use the Level controls to reduce the resistance level at any time. **Each exerciser is responsible for monitoring how he or she feels and adjusting the level of effort accordingly.** If at any time during exercise a user experience chest pains, nausea, dizziness, or shortness of breath, he or she should stop exercising immediately and consult a physician before starting again.

# PRO3700 PRODUCT LABELS

## WARNING

Before starting any exercise program, consult your physician. Machine contains moving parts. To avoid injury keep children and pets clear of the exerciser at all times. Review and follow all warnings and instructions in the owner's manual prior to use.

## WARNUNG

Bevor Sie mit diesem Übungsprogramm beginnen, sollten Sie Ihren Arzt um Rat fragen. Maschine enthält bewegliche Teile. Um Verletzung zu vermeiden halten Sie Ihre Kinder und Haustiere durchgehend von der Maschine entfernt. Lesen und befolgen Sie alle Warnungen und Anweisungen in der Bedienungsanleitung vor Gebrauch.

## AVERTISSEMENT

Avant d'entamer un programme d'exercice, veuillez consulter votre médecin. L'appareil possède des parties mobiles. Pour éviter un accident, les enfants et les animaux domestiques doivent toujours être tenus à l'écart de la machine d'exercice. Avant de vous servir de votre appareil, lisez et suivez tout avertissement et toutes consignes dans le manuel d'utilisateur.

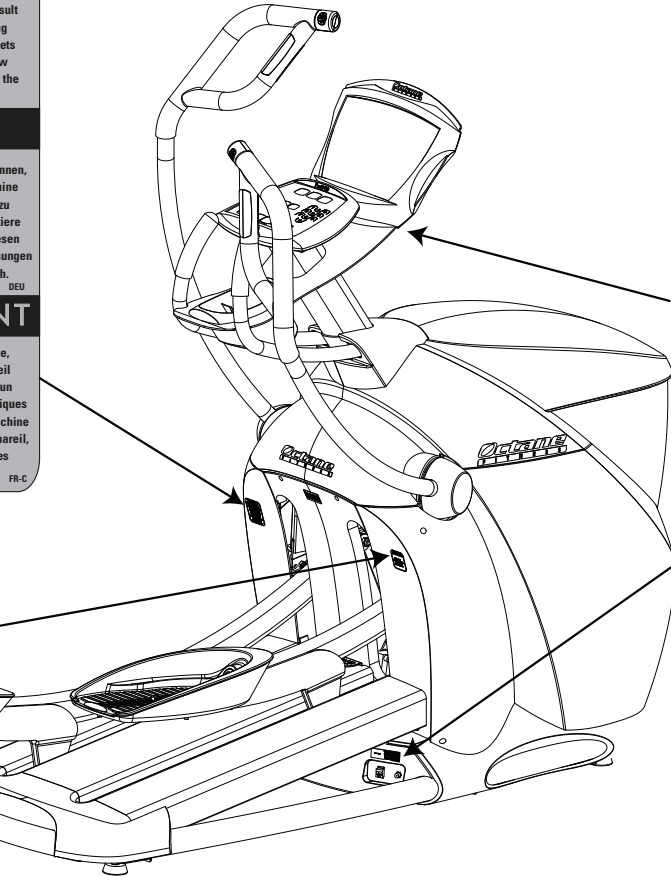

Console Serial Number  
(on lower edge)



Base Serial Number

## CAUTION

Moving parts. Keep children, pets, hands and feet clear during use.

## VORSICHT

Bewegliche Teile. Kinder, Haustiere, Hände und Füße während des Gebrauches entfernt halten.

## ATTENTION

Pièces mobiles. Gardez à l'écart les enfants, les animaux domestiques, les mains et les pieds pendant l'utilisation.

# TABLE OF CONTENTS

<b>Getting Started</b> .....	1
• <b>User Set-Up Functions</b> .....	1
• <b>Cleaning and Maintenance of the PRO3700</b> .....	2
• <b>Troubleshooting &amp; Frequently Asked Questions</b> .....	2
• <b>Warranty Information</b> .....	2
• <b>Optional Kits: CROSS CiRCUIT Pro and Commercial Side Steps</b> .....	2
<b>Electronics</b> .....	3
• <b>PRO3700 Console and Keypad</b> .....	4
• <b>Console Windows</b> .....	7
<b>PRO3700 Programs</b> .....	9
• <b>How Does Workload Resistance (Level) Work?</b> .....	9
• <b>PRO3700 Settings—Value Ranges</b> .....	10
• <b>PRO3700 Program Reference</b> .....	11
<b>PRO3700 Product Features</b> .....	16
• <b>HeartLogic Intelligence</b> .....	16
• <b>MultiGrip Handlebars</b> .....	17
• <b>Fingertip Controls</b> .....	17

# GETTING STARTED

Get ready to Fuel Your Workout with the PRO3700 elliptical cross trainer by Octane Fitness! You will soon be challenging yourself with a variety of pre-programmed workouts, managed by sophisticated electronics that keep you interested and motivated. Getting started is easy—just step on and start pedaling. Follow the Message Center prompts to program your workout, and you are on your way!

## USER SET-UP FUNCTIONS

Many of the standard features and controls of the PRO3700 can be customized to fit your personal preferences or workout environment. In just a few simple steps, you can set up your machine to skip the Warm-Up, countdown your workout time (instead of counting up), limit the maximum workout time, and display units in English or metric. You can also mute the console beeps and adjust the brightness of the display. All of these adjustments are easily completed and are saved as the new standard for the machine—you don't need to reset them for each use.

To access the User Set-up functions, press and hold both the Up Arrow (▲) and Down Arrow (▼) keys for three seconds, or until you hear a beep. The following customizable functions are displayed in sequence in the Message Center; use the Enter key to toggle through the available options (shown in the matrix display) for each function, and press the Up Arrow (▲) or Down Arrow (▼) key to select a setting and move to the next function. To exit without changing any values, press Pause Clear twice.

<b>Warm-Up</b>	This feature may be turned "ON" (to include a 3-minute warm-up in each workout) or "OFF". The factory default setting is "ON".
<b>Clock Direction</b>	The PRO3700 cross-trainer can track workout time by counting "UP" or "DOWN". The factory default setting is "UP".
<b>Max Workout Time</b>	You may set the maximum workout time for users of the PRO3700 to the value that is best for your environment. Use the Enter key to scroll through the possible values (in 5-minute increments), or use the numeric keypad to enter any 1-minute increment between 1:00 and 99:00. Press the Up Arrow (▲) or Down Arrow (▼) key to select the value you desire. The factory default setting is 99 minutes.
<b>Unit Type</b>	You may choose to have the weight and distance units displayed in "ENGLISH" (pounds and miles) or "METRIC" (kilograms and kilometers). The factory default setting is "ENGLISH".
<b>CROSS CIRCUIT Pro</b>	Select "ON" to enable the two CROSS CIRCUIT Pro programs (for use with the optional CROSS CIRCUIT Pro Kit). Factory default is "OFF".
<b>Stride Length</b>	The stride length in the software must be set to the same setting, "JOGGING" or "RUNNING", as the physical position of the stride linkage within the machine. The factory setting is "RUNNING"; if your machine is adjusted to Jogging stride at installation, this console setting should also be set to "JOGGING". You should not change it again unless the physical configuration of the unit is also changed.
<b>Beep</b>	You may turn the console sounds "ON" or "OFF". The factory default setting is "ON".
<b>Brightness</b>	You can adjust the intensity or brightness of the console LEDs, choosing any value between 1 and 8. A higher number represents more light. The factory default setting is 8.
<b>Exit</b>	When EXIT is displayed in the Message Center, press Enter to leave User Set-up. All of your selections will be saved and become the new standard settings for your machine. They may be changed at any time by repeating these set-up procedures.

Two additional button sequences may be useful in your workout environment:

<b>Machine Hours</b>	Press and hold Up Arrow (▲), Program, and Level for three seconds to see the total machine usage, in hours, since the last reset. Press Pause Clear to exit.
<b>New Leaf Assessment</b>	If you are working with New Leaf Fitness professional, press and hold Program and Time for three seconds to access the New Leaf Assessment program. Press Pause Clear to exit.

## Cleaning and Maintenance of the PRO3700

**WARNING!** This machine contains moving parts. Take caution when trying to locate and fix any problem with the machine.

Your Octane Fitness elliptical has been manufactured to withstand many hours of hard use with minimal required maintenance. Simply wipe off the machine with a clean towel after a hard workout to remove any sweat to keep the machine clean. **Do not use bleach on the console as it will damage the lens.**

Please contact your local Octane Fitness dealer should you have any questions or encounter any maintenance issues with your PRO3700. If you would like to speak directly to an Octane Fitness customer service specialist, please call 888.OCTANE4 or 763.757.2662, ext. 1, or visit [www.octanefitness.com](http://www.octanefitness.com).

## Troubleshooting & Frequently Asked Questions

Should you have any questions regarding your PRO3700 elliptical, please log on to [www.octanefitness.com](http://www.octanefitness.com) where you will find answers to many common questions and tips on using your elliptical. If you would like to speak to an Octane Fitness Customer Service specialist, please call 1-888-OCTANE4 or 763-757-2662 extension 1.

## Warranty Information

The PRO3700 elliptical is warranted to be free of all defects in material and workmanship. All parts are warranted for three (3) years from original date of purchase. Labor is covered for one (1) year from original date of purchase. This Limited Commercial Warranty is non-transferable.

Please refer to the Octane Fitness Limited Commercial Warranty and/or the Octane Fitness Limited Consumer Warranty included in your information packet for full details of warranty coverage.

## Optional Kits: CROSS CiRCUIT Pro and Commercial Side Steps

The CROSS CiRCUIT Pro Kit (P/N 105825-001), which includes weight stands and PowerBlocks, is available for the PRO3700. This kit gives you cardio and strength training in one place on your club floor. Two workouts are specifically designed for use with this kit: CROSS CiRCUIT Solo and CROSS CiRCUIT Group.

Also available is the Commercial Side Steps Kit (P/N 105824-001) which provides platforms for users to stand on while performing arm-isolation exercises.

Please contact Octane Fitness Customer Service at 1-888-OCTANE4 or 763-757-2662, extension 1, for pricing and ordering information.



# ELECTRONICS

## PRO3700 Console and Keypad

The PRO3700 features a simple, easy to understand keypad and a console featuring an informative Message Center, a workout profile matrix, and four multi-function LED display windows that provide all the information you need to get started and stay motivated during your workout. Check out the program descriptions found later in this manual to choose the workout that is just right for you.

### **Message Center**

The PRO3700 Message Center features a scrolling LED display which prompts you to enter important information, guides and motivates you through your workout, and rewards you with clear, relevant workout data such as level, average speed, average heart rate, maximum heart rate, calorie/hour, watts, and METs. Watch the message center as you set up and progress through your workout—it will guide you, motivate you, and reward you with summary information at the end of your session.

### **Programming the console**

Getting started is easy—just hop on and start pedaling. The Message Center prompts you to select a program. Once a program is selected, the console display will guide you through the steps to program your workout. After each prompt, simply enter the requested data and press Enter, and you are on your way. If no values are entered at the prompts, the machine defaults to the standard values for the program you have selected.

### **CSAFE Interface**

The PRO3700 is compatible with CSAFE (Communications Specifications for Fitness Equipment) protocol. If you have connected the PRO3700 to your CSAFE network, the user is prompted to enter a 5-digit User ID. The CSAFE user has 30 seconds to enter the User ID digits using the numeric keypad. Once the ID has been entered, the display proceeds with prompting the user for program set-up. If no User ID or program is entered, the machine defaults to the manual program at resistance level 1 and a user weight of 150 pounds (68 kg).

### **Keypad Buttons**

#### **Quick Start**

The easiest way to start a workout is to simply push the Quick Start button, setting the machine in a manual program at resistance level 1, age 40 and weight 150 pounds (68 kg). Then use the keys to set Program, Time or Level, in any order.

#### **Fan**

Press the Fan button to initiate a cool breeze to help keep you comfortable as you work out. Press again to increase the airflow (two additional levels), or a fourth time to turn it off. Move the vent as desired to direct the airflow.

#### **Display Lock**

Press the Display Lock button to stop the display LEDs from toggling between the top and bottom (heart rate) display values in the windows. Press Display Lock a second time to resume toggling.

#### **Cool Down**

It is a good idea to cool-down at the end of your routine to transition your body from an aggressive workout to its normal pace. The time and intensity of the cool-down is automatically customized to your workout duration and resistance level. The time window displays a countdown timer to tell you how long the cool-down will last.

The cool-down will automatically start when time has expired. If you decide to end your workout early, simply push the Cool Down button to activate the custom cool-down.

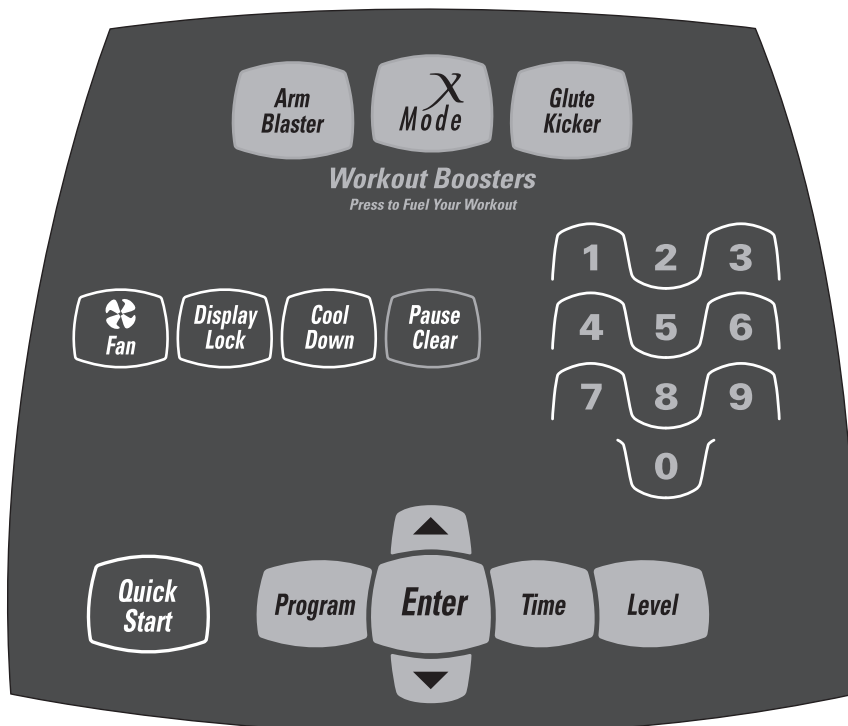
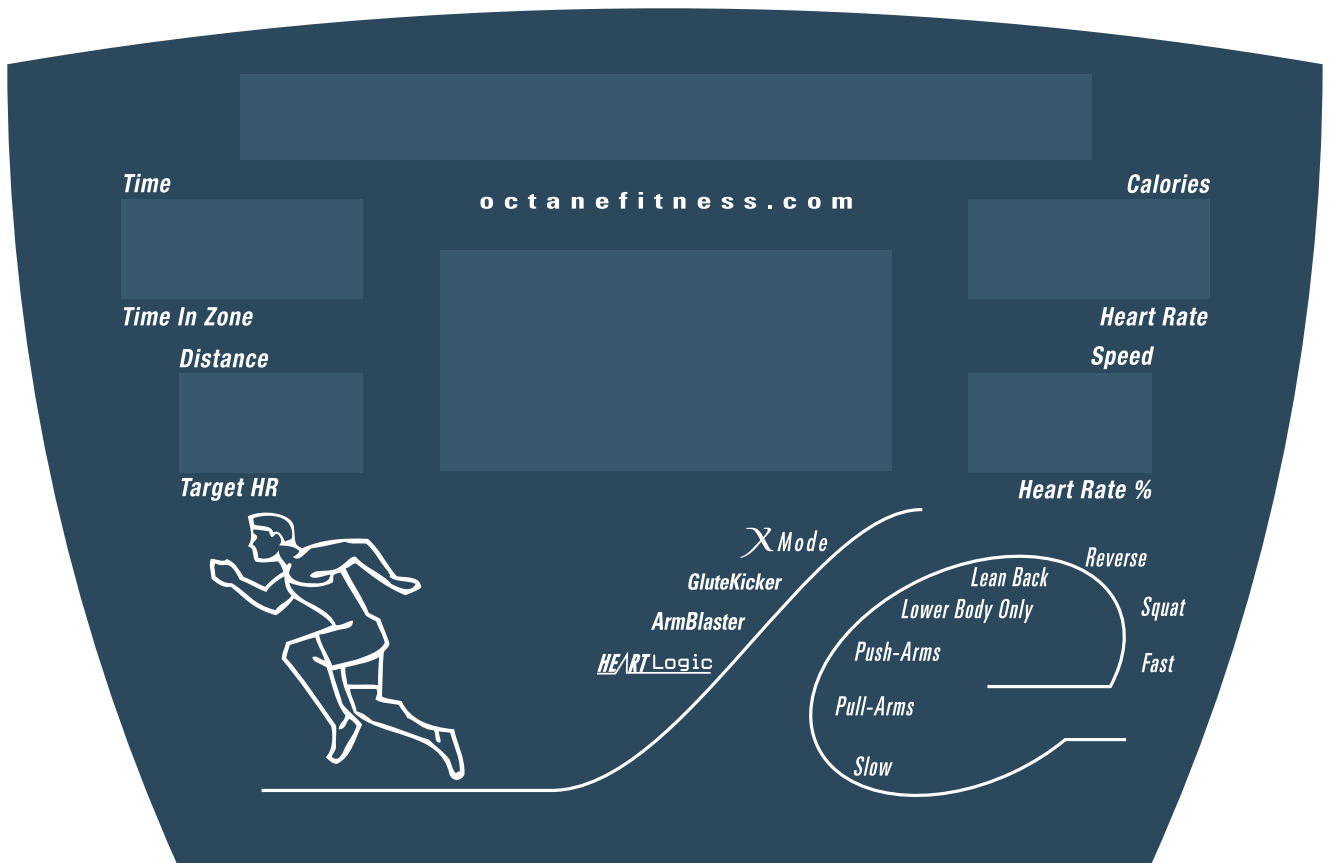

- Pause Clear** To pause your workout, press the Pause Clear button once or simply quit pedaling. The matrix display will indicate how long the pause will last before you need to resume pedaling. Your workout settings and statistics will be saved for the duration of the pause. To restart a paused workout, push any key or start pedaling before the pause countdown reaches zero. To reset the machine for another workout, press the Pause Clear button twice within two seconds.
- Program** Press the Program key to toggle through the available programs. Program changes can be made any time during a workout. When changing programs, the Message Center prompts you to enter new program values as needed.
- Up Arrow (▲)** Use this key during set-up to increase the value of the parameter highlighted in the Message Center, including program, time, level, target heart rate, watts or METs, number of intervals, age, or weight. During a workout, pressing the Up Arrow (▲) key increases the resistance level, target heart rate, or constant output target, depending upon the program.
- Down Arrow (▼)** Use this key during set-up to decrease the value of the parameter highlighted in the Message Center, including program, time, level, target heart rate, watts or METs, number of intervals, age, or weight. During a workout, pressing the Down Arrow (▼) key decreases the resistance level, target heart rate, or constant output target, depending upon the program.
- Enter** Selects any of the changed values or items from the other keys.
- Time** Press Time, then use the Up Arrow (▲) or Down Arrow (▼) key to increase or decrease the time of your workout, in 1 minute increments. The standard workout time is 30:00. The maximum time is 99:00. The maximum time can be changed using the User Set-up Functions.
- Level** Press Up Arrow (▲) or Down Arrow (▼) or the Level button to increase the resistance level of the machine. There are 30 levels of resistance for preset resistance programs and the 30:30 program. For heart rate controlled programs, the Level button increases target heart rate. For the constant power programs, the Level button increases target watts or METs.

*Tip: The Up Arrow (▲) and Down Arrow (▼) buttons on the moving handlebars may be used instead of the keypad buttons to change the level (right handlebar) or program (left handlebar) at any time during set-up or a workout.*

## **Workout Boosters**

- ArmBlaster** ArmBlaster is a proprietary program designed to boost cardiovascular endurance while building strength and muscle tone. Press the ArmBlaster button at any time during your workout to integrate cardio sessions with strength sessions. The cardio session follows the program profile that you have selected. Every minute, resistance increases 10 levels from where you are currently working (or to the maximum resistance of 30) for a muscle-building, 10-repetition set as you transfer the workload from your lower body to your upper body. During the ArmBlaster rep countdown, the level of resistance can be changed by pressing the Up Arrow (▲) or Down Arrow (▼) keys. To deactivate ArmBlaster, simply press the ArmBlaster button a second time.

## X-Mode

Press X-Mode to activate the ultimate cross training tool and take advantage of the variety your elliptical cross trainer offers. This great motivational tool keeps your workout fresh and exciting in any program. Every other minute xMode kicks in, prompting you to perform combinations of eight different challenges:

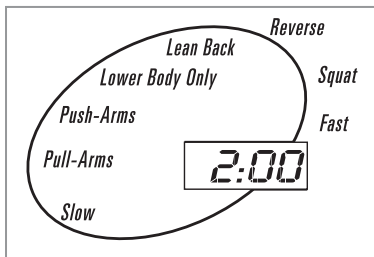

- Fast** Pick up the pace—we recommend 50-60 rpm, but you should find your own comfort level.
- Squat** Bend slightly at the knees. You'll feel this one in your quadriceps and glutes in no time!
- Reverse** Pedal backwards to change the muscle focus on your entire lower body.
- Lean Back** Grab the stationary handlebars and lean slightly backwards, changing the muscle focus on your lower body. You will feel this in your quadriceps.
- Lower Body Only** Either hold the stationary handlebars or naturally swing your arms.
- Push-Arms** Focus on pushing with your arms to work your chest and triceps.
- Pull-Arms** Focus on pulling with your arms to work your biceps and lats.
- Slow** Slow down to allow yourself to recover. We recommend 30-40 rpm.

During an X-Mode session, the level of resistance can be changed by pressing the Up Arrow (▲) or Down Arrow (▼) keys on the keypad or the right handlebar. Deactivate X-Mode by pressing the button a second time.

## GluteKicker

GluteKicker is an aggressive subset of X-Mode that is focused on your glutes, hips, and thighs. It uses four prompts: **Reverse**, **Squat**, **Fast**, and **Lean Back**. GluteKicker sessions last for one minute, with a one-minute recovery period. During the GluteKicker session, the level of resistance can be changed by pressing the Up Arrow (▲) or Down Arrow (▼) keys on the keypad or the right handlebar. Deactivate GluteKicker by pressing the button a second time.

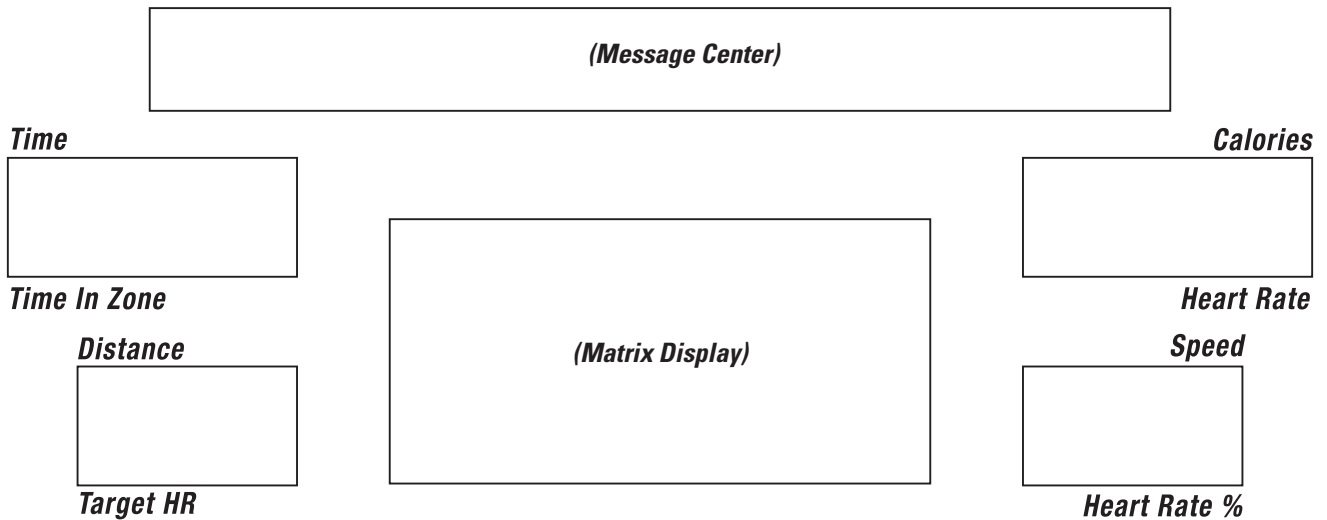

## Console Windows

**Message Center** The PRO3700 Message Center features a scrolling LED display which prompts you to enter important information, guides and motivates you through your workout, and rewards you with clear, relevant workout data such as level, average speed, average heart rate, maximum heart rate, calorie/hour, watts, and METs. Watch the message center as you set up and progress through your workout—it will guide you, motivate you, and reward you with summary information at the end of your session.

**Matrix Display** The matrix display shows the program profile during the workout and highlights upcoming intervals and resistance changes. During heart rate interval programs (Heart Rate Interval, Heart Rate Hill, Heart Rate Speed Interval, Heart Rate Custom Interval, New Leaf Custom), the matrix display is used to inform you of your progress through the intervals:

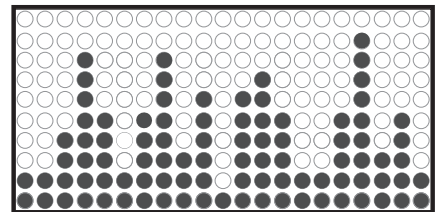

**Changing Target Heart Rates:** When you are trying to reach a new target heart rate, the left side of the matrix display shows an illustration of the interval. The illustration blinks the interval you are attempting to reach. Each column represents one minute. An arrow on the right side of the display shows whether resistance (and therefore your target heart rate) is increasing or decreasing. When decreasing, if the machine reaches resistance level 1 and your heart rate has still not reached your target low, the display prompts you with the message "HR TOO HIGH—SLOW DOWN". When increasing, if the machine reaches the highest resistance level (30) and your heart rate has still not reached your target high, the display prompts you to "INCREASE SPEED TO DECREASE RESISTANCE".

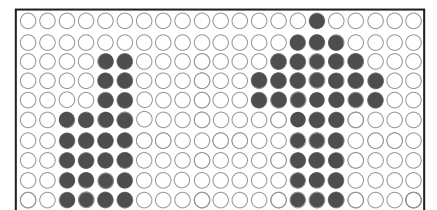

↖ **Upcoming columns blink**

**Interval Duration:** Once you have reached or surpassed the new target heart rate, the matrix display switches to a countdown timer, counting down the length of the interval. The bottom row of the matrix displays a horizontal bar graph representing the current resistance level.

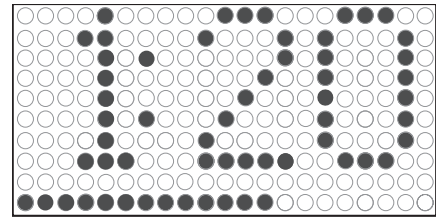

- Time** Displays workout time, counting up from 0:00. Time can be increased or decreased during your workout. The maximum time that users can set is 99:00. When actual workout time is displayed, the timer goes up to 99:59, then rolls over to 0:00. Refer to User Set-up Features to learn how to switch from a “count up” to “count down” display.
- Calories** Displays an estimate of the total calories burned during the workout, based on the user’s entered weight. If no specific weight is entered, calories are based on a 150 lb. (68 kg) user.
- Distance** Displays an estimate of how far you have traveled. Distance can be shown in either miles (English) or kilometers (metric). On the PRO3700, 400 revolutions is approximately one mile; therefore, if you are pedaling at 50 rpm, you will “travel” approximately one mile in 8 minutes. When you first purchase your elliptical the display will be in English. Refer to User Set-up Features to learn how to switch from English to metric.
- Speed** Displays how fast you are going, in revolutions per minute (rpm).
- Time-in-Zone** Tracks and displays the amount of time spent in the proper heart rate training zone for the program. Time-in-Zone is only displayed in a heart rate controlled program when a heart rate is detected by the machine. A user must be wearing a wireless heart rate transmitter or grasping the contact heart rate sensor grips on the moving handlebars.
- Heart Rate** Displays heart rate in beats per minute (BPM). A user must be wearing a wireless heart rate transmitter or grasping the contact heart rate sensor grips on the moving handlebars.
- Target HR** Displays the heart rate reading that the machine is adjusting resistance to achieve when in a heart rate controlled program.
- Heart Rate %** Displays your current heart rate percentage (current heart rate / theoretical maximum heart rate). A user must be wearing a wireless heart rate transmitter or grasping the contact heart rate sensor grips on the moving handlebars and have entered an age.

# PRO3700 PROGRAMS

The PRO3700 features 19 built-in programs to keep workouts interesting:

Preset resistance programs: Manual—Random—Interval—Custom Interval—Hill—10K  
Heart rate controlled programs: Fat Burn—Cardio—Heart Rate Interval—Heart Rate Custom Interval—Heart Rate Hill—Heart Rate Speed Interval  
Advanced programs: New Leaf Custom—Constant Watts—Constant METs—30-30—MMA—CROSS CIRCUIT Solo—CROSS CIRCUIT Group

Programs begin with a warm-up to ease the body into the workout. During the warm-up, the resistance increases each minute.

Preset resistance and advanced incorporate a three-minute warm-up during which resistance increases two levels per minute. Heart rate controlled programs include a warm-up which lasts three minutes or until you reach your target heart rate; then your selected program begins. Increasing or decreasing the Level changes the target heart rate.

## How Does Workload Resistance (Level) Work?

### Resistance Level

The PRO3700 has 30 discrete levels of resistance. Level 1 is the easiest and level 30 is the most difficult. The Manual program and Quick Start give the user the ability to totally control the resistance level. Interval Programs (Interval, Custom Interval, and 30-30) allow the user to select the resistance level for specific intervals.

For all programs except the Goal Programs (resistance level is represented by rows of LEDs in the matrix display. Each row that is lit represents 3 resistance levels. The table below will help you understand and interpret the matrix display:

Resistance Levels	LED Rows Lit	Resistance Levels	LED Rows Lit
1-3	1	16-18	6
4-6	2	19-21	7
7-9	3	22-24	8
10-12	4	25-27	9
13-15	5	28-30	10

### Program Level

The Random, Hill, and 10K programs allow the user to select an overall resistance level for the program. This level is the average resistance level for the workout. The range of resistance levels during these workouts are  $\pm 4$  of the entered program level (i.e., For program Level 5, minimum resistance is Level 1 and maximum resistance is Level 9). During the workout, the overall program resistance level is displayed on the console.

### Resistance in “Constant” Programs

The Constant Watts and Constant METs programs allow the user to enter the power output level, in watts or METs, for the program. The resistance level during these constant workouts is controlled by the machine, increasing or decreasing as necessary in tandem with the user’s speed to keep the output on target.

**Resistance in Heart Rate Controlled Programs**

These programs (Fat Burn, Cardio, Heart Rate Interval, Heart Rate Custom Interval, New Leaf Custom, Heart Rate Hill, and Heart Rate Speed Interval) allow the user to manually enter the target heart rate level for program. If the target HR is reached during the warm-up, the warm-up ends and the selected heart rate control program begins. The resistance level during the heart rate controlled workout is controlled by the machine, increasing or decreasing as necessary to keep the user’s heart rate on target.

Exercisers choose the program that best fits their workout needs for any given day. They can decide how hard to work by setting the resistance level and time for each program. Four programs—Manual, Custom Interval, Custom Heart Rate Interval, and New Leaf Custom—provide even more flexibility to program individual workouts to meet specific needs.

Use the quick-reference chart on the following pages to help select and set up the programs, or read on for more detailed descriptions.

**Note:** *The PRO3700 also includes a fitness assessment program to be used as part of an Active Metabolic Assessment conducted by a certified New Leaf Fitness fitness consultant. To learn how to take advantage of this unique opportunity for PRO3700 users, contact Octane Fitness at 1.888.OCTANE4.*



<b>PRO3700 SETTINGS—VALUE RANGES</b>			
<b>Setting</b>	<b>Standard Values*</b>	<b>Minimum Value</b>	<b>Maximum Value</b>
Workout Time	30:00	1:00	99:00
Level	1	1	30
Age	40	15	99
Weight	150 lbs. (68 kg)	70 lbs. (32 kg)	400 lbs. (181 kg)
Interval Time	00:30	00:15	99:00
Interval Level	1	1	30
How Many Intervals	3	2	6
Target Heart Rate	(220 - Age) * %; varies by program	80	(220 - Age)
Watts	125	20	900
METs	7.0	1.0	varies
High Level	5	1	30
Cardio Time	2:00	00:30	10:00
Strength Reps	10	8	30
Intensity	Low	Low	High
Fight Level	6	1	30
Rounds	3	1	10

*\*Standard program values are used if no values are entered within 4 seconds of Message Center prompts.*



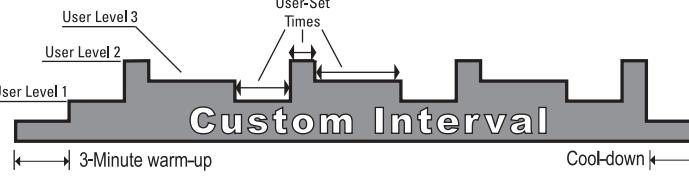
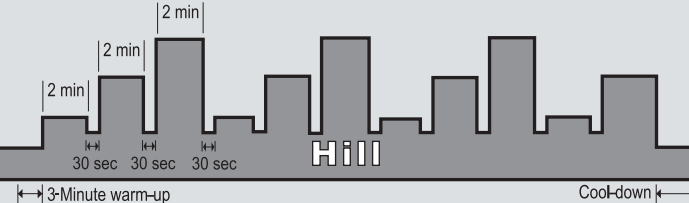

# PRO3700 PROGRAM REFERENCE

Use the numeric keypad or the Up Arrow (▲) and Down Arrow (▼) keys on the keypad or the right handlebar to enter program settings as prompted by the Message Center.

Programs & Standard Settings	Description
 <p style="text-align: center;"><b>Manual</b></p> <p style="text-align: center;">Workout Time (30:00) Level (1) Age (40) Weight (150 lbs./68 kg)</p>	<p>Get on and go; constant resistance simulates walking or jogging on a flat surface. The oval racetrack equals 1/4 mile (or 400 meters); the counter in the matrix display shows laps completed.</p>
 <p style="text-align: center;"><b>Random</b></p> <p style="text-align: center;">3-Minute warm-up   Cool-down</p> <p style="text-align: center;">Workout Time (30:00) Level (1) Age (40) Weight (150 lbs./68 kg)</p>	<p>Enjoy computer-randomized resistance variation with a virtually infinite number of combinations. Get a new course each time you select the program or change the level. Each interval lasts one minute.</p>
 <p style="text-align: center;"><b>Interval</b></p> <p style="text-align: center;">3 Minute warm-up   Cool-down</p> <p style="text-align: center;">Workout Time (30:00) 1st Interval Level (1) 2nd Interval Level (4) Age (40) Weight (150 lbs./68 kg)</p>	<p>Add variety and challenge with 2-minute intervals of alternating user-set resistance. Use Up Arrow (▲) and Down Arrow (▼) on the keypad or right handlebar to adjust interval resistance mid-workout.</p>
 <p style="text-align: center;"><b>Custom Interval</b></p> <p style="text-align: center;">3-Minute warm-up   Cool-down</p> <p style="text-align: center;">Workout Time (30:00) How Many Intervals (3) Interval 1 — Time (00:30) Interval 1 — Level (1) Interval n — Time (00:30) Interval n — Level (1) Age (40) Weight (150 lbs./68 kg)</p>	<p>Design a custom workout of up to 6 alternating intervals of user-defined duration and resistance. Use Up Arrow (▲) and Down Arrow (▼) on the keypad or right handlebar to adjust interval resistance mid-workout.</p>
 <p style="text-align: center;"><b>Hill</b></p> <p style="text-align: center;">3-Minute warm-up   Cool-down</p> <p style="text-align: center;">Workout Time (30:00) Level (1) Age (40) Weight (150 lbs./68 kg)</p>	<p>Build strength with this simulated climb up 3 increasingly steeper hills. Each hill lasts two minutes with a 30-second recovery in between. After the biggest hill, recover for 30 seconds, then begin your climb again.</p>

# PRO3700 PROGRAM REFERENCE

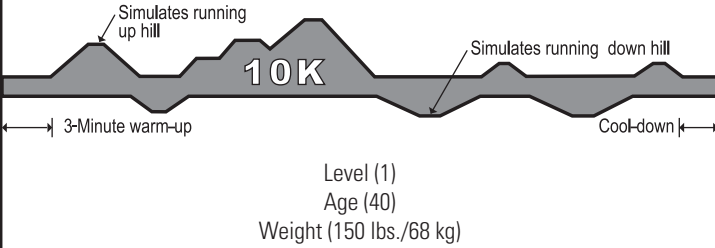
Use the numeric keypad or the Up Arrow (▲) and Down Arrow (▼) keys on the keypad or the right handlebar to enter program settings as prompted by the Message Center.

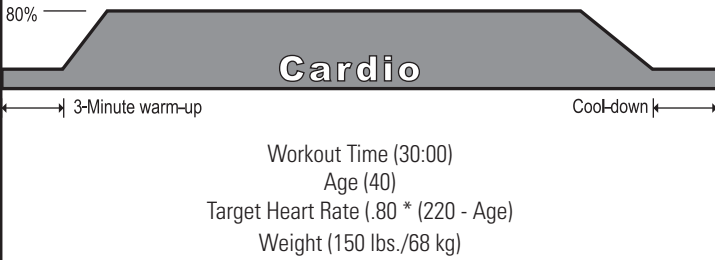
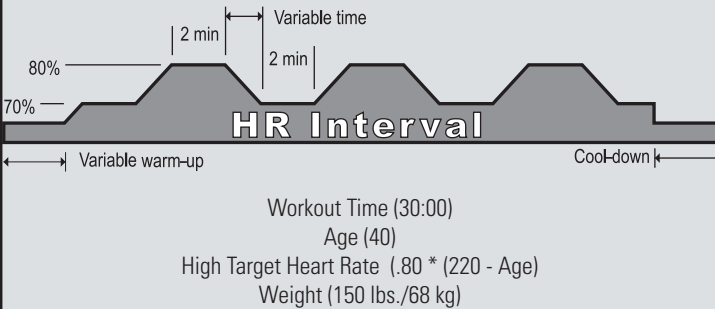
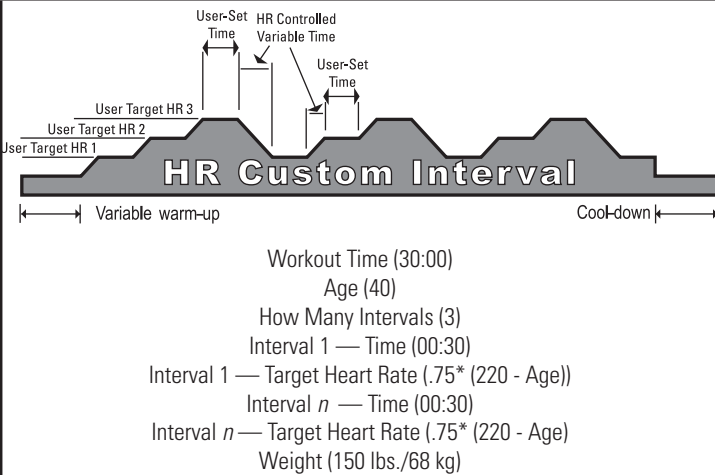
Programs & Standard Settings	Description
 <p><b>10K</b></p> <p>Simulates running up hill</p> <p>Simulates running down hill</p> <p>3-Minute warm-up</p> <p>Cool-down</p> <p>Level (1) Age (40) Weight (150 lbs./68 kg)</p>	<p>Complete a virtual 10K—a great way to train for an actual event. Gradual resistance changes simulate variance in terrain, replicating the challenges encountered when walking or running outside. The distance readout counts down from 6.2 miles (10 kilometers). Use Up Arrow (▲) and Down Arrow (▼) on the keypad or right handlebar to adjust level during the workout.</p>
 <p><b>Fat Burn</b></p> <p>65%</p> <p>Variable warm-up</p> <p>Cool-down</p> <p>Workout Time (30:00) Age (40) Target Heart Rate (.65 * (220 - Age)) Weight (150 lbs./68 kg)</p>	<p>Maximize the percentage of calories burned from fat versus carbohydrates with this controlled workout at 65% of theoretical maximum heart rate (or user-specified target heart rate). Use Up Arrow (▲) and Down Arrow (▼) on the keypad or right handlebar to adjust interval target heart rates mid-workout.</p>
 <p><b>Cardio</b></p> <p>80%</p> <p>3-Minute warm-up</p> <p>Cool-down</p> <p>Workout Time (30:00) Age (40) Target Heart Rate (.80 * (220 - Age)) Weight (150 lbs./68 kg)</p>	<p>Maximize cardiovascular benefits with this controlled workout at 80% of theoretical maximum heart rate (or user-specified target heart rate). Use Up Arrow (▲) and Down Arrow (▼) on the keypad or right handlebar to adjust interval target heart rates mid-workout.</p>
 <p><b>HR Interval</b></p> <p>80%</p> <p>70%</p> <p>2 min</p> <p>2 min</p> <p>Variable time</p> <p>Variable warm-up</p> <p>Cool-down</p> <p>Workout Time (30:00) Age (40) High Target Heart Rate (.80 * (220 - Age)) Weight (150 lbs./68 kg)</p>	<p>Capturing the benefits of interval training over steady-state training in this controlled workout of alternating 2-minute intervals at 70% and 80% of theoretical maximum heart rate (or user-specified target heart rate). Intervals last two minutes after the target heart rate has been reached. Use Up Arrow (▲) and Down Arrow (▼) on the keypad or right handlebar to adjust interval target heart rates mid-workout.</p>
 <p><b>HR Custom Interval</b></p> <p>User-Set Time</p> <p>HR Controlled Variable Time</p> <p>User-Set Time</p> <p>User Target HR 3</p> <p>User Target HR 2</p> <p>User Target HR 1</p> <p>Variable warm-up</p> <p>Cool-down</p> <p>Workout Time (30:00) Age (40) How Many Intervals (3) Interval 1 — Time (00:30) Interval 1 — Target Heart Rate (.75 * (220 - Age)) Interval n — Time (00:30) Interval n — Target Heart Rate (.75 * (220 - Age)) Weight (150 lbs./68 kg)</p>	<p>Build a custom heart-rate controlled workout of up to 6 alternating intervals of user-defined duration and target heart rates. Use Up Arrow (▲) and Down Arrow (▼) on the keypad or right handlebar to adjust interval target heart rates mid-workout.</p>

# PRO3700 PROGRAM REFERENCE

Use the numeric keypad or the Up Arrow (▲) and Down Arrow (▼) keys on the keypad or the right handlebar to enter program settings as prompted by the Message Center.

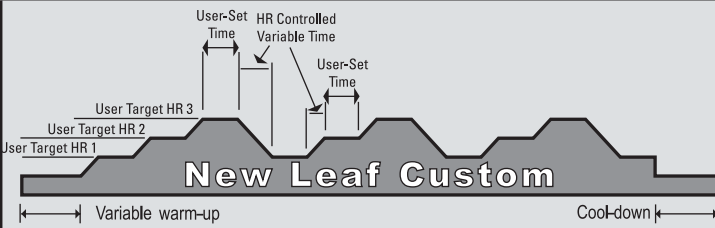
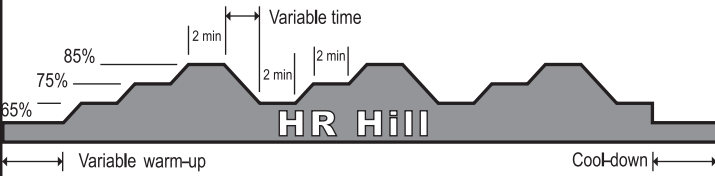
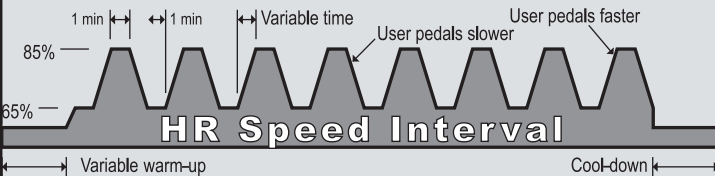
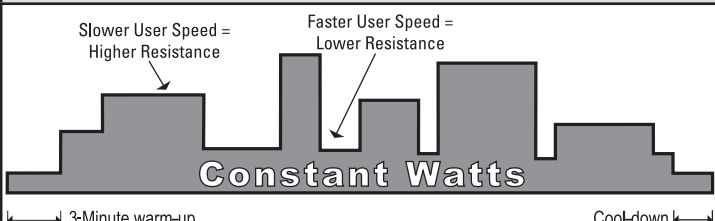
Programs & Standard Settings	Description
 <p><b>New Leaf Custom</b></p> <p>Workout Time (30:00) Age (40) How Many Intervals (3) Interval 1 — Time (00:30) Interval 1 — Target Heart Rate (.75* (220 - Age)) Interval <i>n</i> — Time Interval <i>n</i> — Target Heart Rate (.75* (220 - Age)) Weight (150 lbs./68 kg)</p>	<p>Follow the recommended plan designed just for you after completing a New Leaf fitness assessment. This controlled workout incorporates up to 6 alternating intervals of user-defined duration and target heart rates. <i>To learn about the New Leaf fitness assessment for PRO3700 users, contact Octane Fitness at 1.888.OCTANE4.</i></p>
 <p><b>HR Hill</b></p> <p>Workout Time (30:00) Age (40) High Target Heart Rate (.85* (220 - Age)) Weight (150 lbs./68 kg)</p>	<p>Get a great interval workout with this controlled simulated climb of increasingly steeper hills at 65%, 75%, and 85% of theoretical maximum heart rate (or user-specified target heart rate). Each hill lasts two minutes once the target heart rate has been reached. After the biggest hill, recover until your heart rate drops back to 65%, then begin the climb again.</p>
 <p><b>HR Speed Interval</b></p> <p>Workout Time (30:00) Age (40) High Target Heart Rate (.85* (220 - Age)) Weight (150 lbs./68 kg)</p>	<p>Focus on power and speed in this controlled workout that alternates one-minute intervals of 65% and 85% of theoretical maximum heart rate (or user-specified target heart rate). This challenging workout combines steeper (higher resistance) intervals with changing speeds. Intervals last one minute after the target heart rate has been reached.</p>
 <p><b>Constant Watts</b></p> <p>Workout Time (30:00) Age (40) Weight (150 lbs./68 kg) Watts (125)</p>	<p>Set a target power output and let the machine keep you there by varying resistance level relative to your speed. Power output is measured in watts, representing the amount of power required by the machine to maintain the workload (pedal resistance and speed) that you want to experience. The higher the watts, the more difficult the workout.</p>

# PRO3700 PROGRAM REFERENCE

Use the numeric keypad or the Up Arrow (▲) and Down Arrow (▼) keys on the keypad or the right handlebar to enter program settings as prompted by the Message Center.

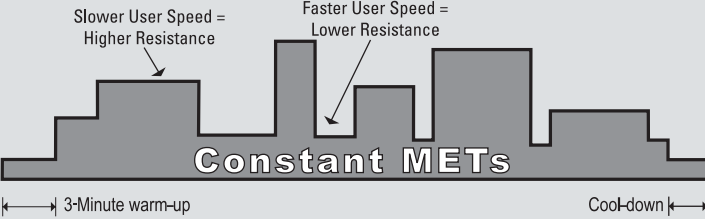
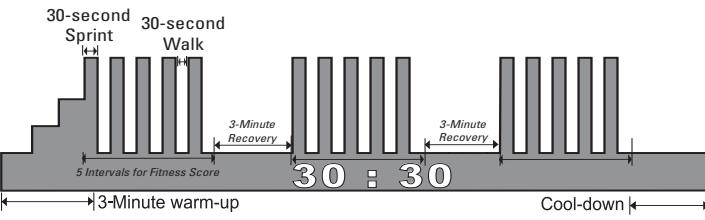
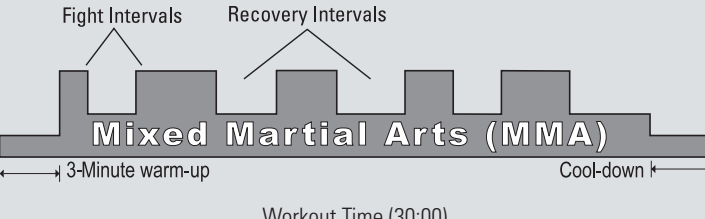
Programs & Standard Settings	Description
 <p>Slower User Speed = Higher Resistance</p> <p>Faster User Speed = Lower Resistance</p> <p><b>Constant METs</b></p> <p>3-Minute warm-up</p> <p>Cool-down</p> <p>Workout Time (30:00) Age (40) Weight (150 lbs./68 kg) METs (7.0)</p>	<p>Gauge the intensity of your workout by setting a target output measured in metabolic equivalent units (METs). The machine keeps you on goal by varying resistance level relative to speed. METs are a measure of power output, representing the ratio of a person's working metabolic rate relative to that person's resting metabolic rate. One MET is approximately equal to 1 kilocalorie burned per kilogram per hour. The greater the METs, the harder the workout.</p>
 <p>30-second Sprint</p> <p>30-second Walk</p> <p>3-Minute Recovery</p> <p>5 Intervals for Fitness Score</p> <p><b>30 : 30</b></p> <p>3-Minute warm-up</p> <p>Cool-down</p> <p>Workout Time (30:00) High Interval Level (8) Age (40) Weight (150 lbs./68 kg)</p>	<p>This challenging program provides a simple test of fitness level with 5 sets of 30-second sprint and recovery intervals. For each set, the program monitors heart rate and calculates the average minimum and average maximum heart rates and the average number of beats the heart rate recovers between sprint intervals. Heart rate recovery is a relative indicator of fitness level; a higher number indicates a more rapid heart rate recovery and therefore represents a relatively better level of fitness.</p>
 <p>Fight Intervals</p> <p>Recovery Intervals</p> <p><b>Mixed Martial Arts (MMA)</b></p> <p>3-Minute warm-up</p> <p>Cool-down</p> <p>Workout Time (30:00) Age (40) Weight (150 lbs./68 kg) Intensity (Medium) Fight Level (6) Rounds (3)</p>	<p>Take on your toughest opponent yet—the Octane elliptical! Battle it out in 5-minute rounds that include 5 alternating 'fight' and 'recover' intervals of various lengths. The harder you punch with your arms, the harder the Octane elliptical 'fights back' with increased resistance. This great workout gets your heart—and your fists—pumping!</p>

# PRO3700 PROGRAM REFERENCE

Use the numeric keypad or the Up Arrow (▲) and Down Arrow (▼) keys on the keypad or the right handlebar to enter program settings as prompted by the Message Center.

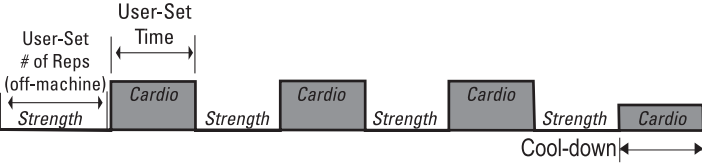
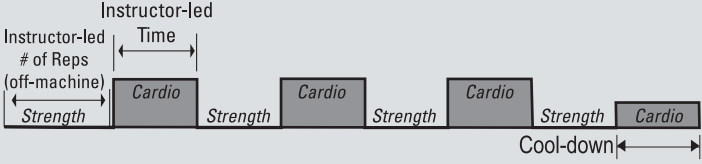
Programs & Standard Settings	Description
 <p><b>CROSS CiRCUIT Solo</b></p> <p>Time (30:00)            Level (1)            Cardio Time (2:00)            Strength Reps (10)            Age (40)            Weight (150)</p>	<p>Maximize the impact of your workout time with this challenging on- and off-machine cross-training routine. Follow the prompts to complete alternating sets of cardio and strength exercises. Use Level (+) or (-) to adjust the cardio interval resistance mid-workout.</p>
 <p><b>CROSS CiRCUIT Group</b></p> <p>Level (1)            Age (40)            Weight (150)</p>	<p>Group exercise on an elliptical! Ramp up your workout with this instructor-led on- and off-machine cross-training routine. Follow the leader's instructions to complete alternating sets of cardio and strength exercises.</p>

\*Standard program values are used if no values are entered within 4 seconds of Message Center prompts.

# PRO3700 PRODUCT FEATURES

The Octane Fitness PRO3700 elliptical incorporates additional features to ensure that users experience great workouts, including HeartLogic Intelligence and MultiGrip Handlebars. In addition, many of the standard features and controls of your Octane Fitness elliptical can be customized to fit your personal preferences or workout environment.

## HeartLogic Intelligence

The PRO3700 is equipped with HeartLogic Intelligence—Octane’s own heart rate control technology. HeartLogic Intelligence is a sophisticated yet easy to use technology that provides the most accurate and effective workout possible. It all begins with the wireless chest strap and the digital contact heart rate grip sensors on the moving handlebars. There are seven different heart rate programs—Fat Burn, Cardio, Heart Rate Interval, Heart Rate Hill, Heart Rate Speed Interval, Heart Rate Custom Interval, and New Leaf Custom—to keep workouts fun and interesting. To top it all off, the console displays time-in-zone, current heart rate, heart rate %, and target heart rate so you know exactly where you are and where you should be.

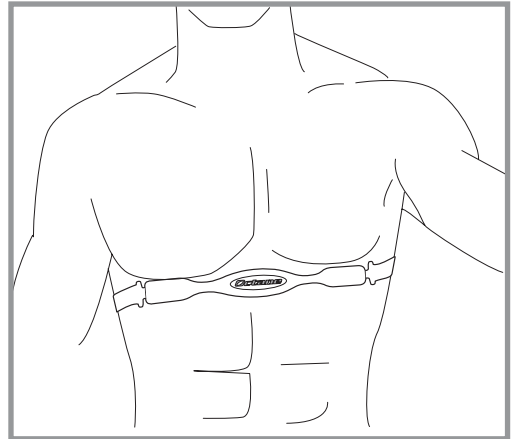

### Using a wireless chest strap

The wireless chest strap transmits your heart rate to the electronics console at a distance of up to three feet. You may use any Polar™-compatible (coded or non-coded) transmitter. Adjust the length of the elastic strap and fasten the transmitter around your torso, underneath your shirt. Place the strap just below your chest. Make sure the logo is away from you and right side up. It may help to moisten the electrodes on the back of the transmitter with a small amount of water for better contact with the skin. The electrodes are the ribbed portion on the back side of the transmitter that sits against your skin. Make sure the strap fits snugly but doesn't restrict breathing. The contact handgrips reading takes priority if both the wireless and contact heart rate grips are in use.

### Using the digital contact heart rate sensors

The digital contact heart rate sensors are located on the moving handlebars of the PRO3700. The grips can be used to check your heart rate during your workout. For the most accurate heart rate reading possible, grasp each contact heart rate grip so that the contact sensor portion of the grip rests in the palm of your hand. Grip the contact sensors firmly, and keep your hands steady and in place.

### Heart rate programs

The PRO3700 provides several different heart rate controlled programs to offer you more variety to suit your personal needs. We recommend that you try different programs to determine your favorite. Refer to the PRO3700 Program Reference chart for more information.

## MultiGrip Handlebars

Your Octane Fitness cross trainer features one-of-a-kind handlebars that deliver the ultimate upper-body workout with virtually unlimited options for maximal comfort, customization, and effectiveness. The unique MultiGrip handlebars with converging motion are only offered by Octane, and these innovative handlebars have revolutionized how you workout your upper-body. The MultiGrip handlebars are comfortable in any position, whether you're hanging on loosely for a brief, easy workout, or gripping the MultiGrip handlebars tightly to complete a lengthy, heart-pumping, high-intensity workout session.

The converging motion and unique design of the MultiGrip handlebars fit every exerciser—tall, short, slender, bigger framed, and even those with shorter or longer arms—providing a multitude of choices that result in the most comfortable and ergonomically correct positions of any cross trainer. You will feel the difference! Here's how they can be put to work for you:

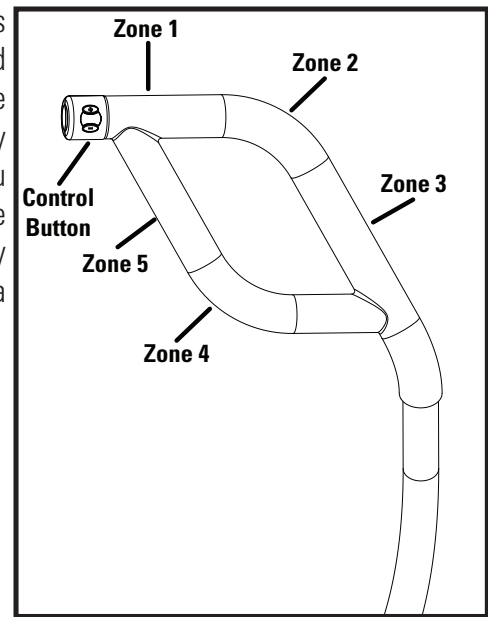

Zone 1	Top horizontal position	Ideal for pushing Gives longer range of motion Engages the deltoid (shoulder) and lat (back) muscles
Zone 2	Large corner position Widest position	Push with the palms; better stability for a excellent chest press motion Focuses more on using the pectoral (chest) muscles
Zone 3	Wide grip	Emphasizes pectoral (chest) and lat (back) muscles
Zone 4	Low inside position	Shorter range of motion Suitable for lighter workouts with less upper-body involvement Great position for squatting down and pedaling in reverse Simulates runners movement or when moving fast
Zone 5	Narrow vertical position	Great for pulling or pushing of the arms Focuses on the lat (back), triceps (back of arm), and biceps (front of arm) muscles

No matter what position or zone you select, you're working numerous different muscle groups throughout your upper-body to get a true elliptical cross training workout. You can emphasize either a push or pull movement or reposition your hands any time during any program for maximal muscle exertion, balance, variety, and comfort.

## Fingertip Controls

The PRO3700 also features fingertip control buttons on the handlebars. You can easily set up or adjust the Level (or Target Heart Rate) while in a workout using the Up Arrow (▲) and Down Arrow (▼) on the right handlebar. Or, adjust the Program at any time using the Up Arrow (▲) and Down Arrow (▼) on the left handlebar. These convenient buttons let you adjust settings to meet your needs without breaking the flow of the workout.

## Learn More at [www.octanefitness.com](http://www.octanefitness.com)

Log on to [www.octanefitness.com](http://www.octanefitness.com) where you will find additional information about product features and answers to many common questions and tips on using your elliptical. If you would like to speak to an Octane Fitness Customer Service specialist, please call 1-888-OCTANE4 or 763-757-2662, extension 1.

## ***Are you passionate about your workout and the results?***

Share your story with others on the Octane Fitness web site.

Go to: ***www.octanefitness.com/testimonials***

Then click on "Share My Story" and  
show the world how fueled you are.

*www.octanefitness.com*

*www.youtube.com/user/octanefitness*



Find us on  
Facebook

*www.facebook.com/octanefitness*

**F U E L   Y O U R   L I F E <sup>TM</sup>**

***Octane***<sup>®</sup>  
**F I T N E S S**

### **Octane Fitness**

*US & Canada, Latin America, Asia & Asian Pacific*

7601 Northland Drive North

Suite 100

Brooklyn Park, MN 55428

Phone: 888.OCTANE4 (US and Canada)

763.757.2662 (Latin America, Asia and Asian Pacific)

Fax: 763.323.2064

### **Octane Fitness International**

*Europe, Middle East, Africa*

Rivium Westlaan 19

2909 LD, Capelle a/d IJssel

The Netherlands

Phone: +31 10 2662412

Fax: +31 10 2662444

©2012 Octane Fitness, LLC. All rights reserved. Octane Fitness, DedicatedLogic, Fuel Your Life, HeartLogic, Now-Zone, X-Mode, ArmBlaster, CROSS CIRCUIT Pro and GluteKicker are registered trademarks of Octane Fitness. Any use of these trademarks, without the express written consent of Octane Fitness, is forbidden.

107665-001 REV A